

Control
number

02017-9E-015

Digi-Key



SPECIFICATION	
Poly-carbonmonofluoride Lithium Battery	
Ordering Code :	BR-1/2AAE2PN
Model Code :	BR-1/2AA

Approved by
Division/Department
Name
Title
Signature/date

ISSUED
Sep,25,2017
PT. Panasonic Gobel Energy Indonesia

Date of Issued : Sep,25,2017

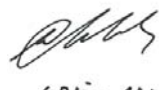
PT. Panasonic Gobel Energy Indonesia

Approved	Checked	Drafted
 K. Panano	 Widi AN	 Dardang K

Revision history

No.	Date	Revision
1	Sep,25,2017	Issued
2		
3		
4		
5		
6		
7		
8		
9		
10		
11		
12		
13		
14		
15		
16		
17		
18		
19		
20		

1. Application Range

This specification is applied to poly-carbonmonofluoride Lithium batteries manufactured by Panasonic Corporation Automotive & Industrial Systems Company (AIS Company).

2. Nominal Specification

2-1 Model Number	BR-1/2AAE2PN (Bare cell: BR-1/2AA)
2-2 Nominal Voltage	3V
2-3 Nominal Capacity	1,000mAh (Nominal capacity is based on the standard discharge current and cut-off voltage 1.8V at 20°C.)
2-4 Standard Discharge Current	2.5mA
2-5 Maximum Discharge Current	50 mA (continuous) 300 mA (for 1 sec.)
2-6 Dimensions	See attached drawing
2-7 Mass	Approximately 8g
2-8 Appearance	No noticeable deformation
2-9 Temperature	Operating; -40 to +100°C (Non condensing) Non-operating; -20 to 45°C (Non condensing) (Note: Contact Panasonic in case of using the battery in out of the specified temperature range above.)
2-10 Recommendable Storage Condition	Temperature: 5°C to 35°C Humidity: Less than 70%RH
2-11 Battery Composition	Lithium primary battery composed of cathode from poly-carbonmonofluoride, anode from lithium, and electrolyte from organic solvent and lithium salt.

3. Characteristics

3-1 Open Circuit Voltage	
3-1-1 Initial	Between 3.0 and 3.5V (The measuring method is described in item 5-4-1.)
3-1-2 After 1 year storage at 25±5°C (humidity : less than 70%RH)	Between 3.0 and 3.5V (The measuring method is described in item 5-4-1.)
3-2 Impedance	
3-2-1 Initial	Between 0.1 and 1.0 Ω (The measuring method is described in item 5-4-2.)
3-1-2 After 1 year storage at 25±5°C (humidity : less than 70%RH)	Between 0.1 and 1.0 Ω (The measuring method is described in item 5-4-2.)
3-3 Duration	
3-3-1 Initial	300h MIN. (20±3°C) (The measuring method is described in item 5-4-3.)
3-3-2 After 1 year storage at 25±5°C (humidity : less than 70%RH)	300h MIN. (20±3°C) (The measuring method is described in item 5-4-3.)
3-4 Vibration Resistance	Deterioration of performance (3-1) shall not occur after the test described in item 5-4-4.
3-5 High Temperature Storage	The battery shall not show leakage or salting after the high temperature storage described in item 5-4-5.

4. Test Condition

4-1 Test Condition	Unless otherwise specified the test shall be carried out at, Temperature : $20 \pm 15^{\circ}\text{C}$ Humidity : $65 \pm 20\% \text{RH}$
4-2 Test Timing	The test shall be started within a month from delivered day.
4-3 Measurement Instrument	
4-3-1 Voltage Meter	Input impedance : $\geq 10\text{M}\Omega$
4-3-2 Battery Impedance Meter	Measurement error : $\leq 0.5\%$ Sine-wave AC method (1kHz, 0.1mA) (As a general, Agilent Technologies LCR Meter [4338B] is recommended.)
4-3-3 Caliper	Class 1 of JIS B 7507:1993
4-3-4 Balance	Sensitivity : $\leq 100\text{mg}$

5. Measuring Method

5-1 Dimensions	This shall be measured with the caliper described in item 4-3-3.
5-2 Mass	This shall be measured with the balance described in item 4-3-4.
5-3 Appearance	Deformation or tarnish shall be checked by visual observation method.
5-4 Characteristics	
5-4-1 Open Circuit Voltage	This shall be measured with the voltage meter described in item 4-3-1.
5-4-2 Impedance	This shall be measured with the impedance meter described in item 4-3-2.
5-4-3 Duration	This shall be measured by constant resistance discharge method. Test temperature : $20 \pm 3^{\circ}\text{C}$ Load resistance : $1\text{k}\Omega$ End voltage: 1.8V
5-4-4 Vibration Test	This test shall be carried out by the following condition according to UN Manual of Test and Criteria, Part III, sub-section 38.3.4.5, Amplitude: 0.8mm Frequency: $7 \leftrightarrow 200\text{Hz}$ Directions: X, Y, Z Duration: 15 minutes, 12 times (each direction)
5-4-5 High Temperature Storage	The battery shall be stored at 60°C for 1 month. After the storage, the battery shall be kept in dry place at $25 \pm 5^{\circ}\text{C}$ during 4hours, then leakage and appearance shall be checked by visual observation method.

6. Indication

6.1 Below items are indicated on the side surface of the battery.
(Design of indication is possibly modified without prior announcement.)

Model code	BR-1/2AA
Nominal voltage	3V
Manufacture or its brand	Panasonic
Production	Japan

6.2 Date Code System

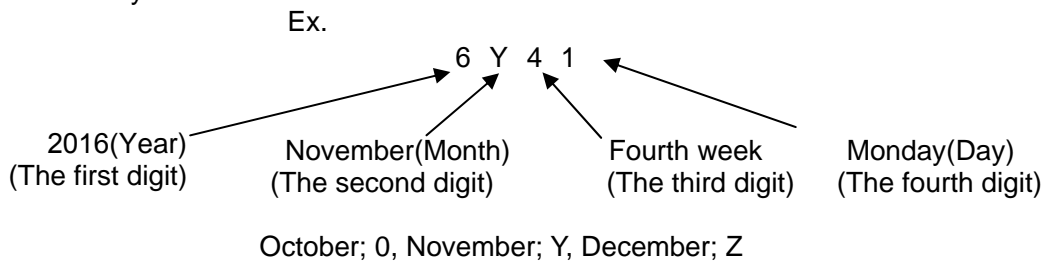

6.3 UL Standard

This battery is certificated by UL and listed on the file number MH12210, and it is available to review that in the UL web site (<http://www.ul.com>).

6.4 Production Site

Panasonic Corporation Automotive & Industrial Systems Company (AIS Company).
1-1 Matsushita-cho, Moriguchi-city, Osaka, 570-8511, Japan

7. Operations and Modification of This Specification

Modification must be carried out under mutual agreement.

Any accidents caused by non-described items in this specification must be discussed and solved mutually.

8. Important Notes (Warranty)

1) The batteries are warranted to conform to the description contained in this Specification for a period of twelve [12] months from the ex-factory date and any claim by you (customer) must be made within such period. During that warranty period, if the Batteries are proved to become defective, non-defective and conforming Batteries will be supplied in due course at sole expense of Panasonic Corporation AIS Company (Panasonic) upon Panasonic's own determination that this is apparently caused by negligence of Panasonic. Any further claims based on the delivery of defective Batteries shall be excluded. Such exclusion shall not affect the liability of Panasonic based on product liability for grossly negligence or intentional behavior of Panasonic.

2) Confirmation of the matching and reliability of Batteries into your actual sets or units is your own responsibility.

3) Panasonic shall not warrant or be responsible in any case where your fails to carry out proper handling, operating, installation, testing, service and checkout of the batteries and/or to follow the instructions, cautions, warnings, notes provided in this Specifications, or other Panasonic's reasonable instructions or advice.

9. Others

- 1) This product specification will be validated assuming that it is accepted when it is not returned within six months from the date of issue.
- 2) This battery is classified as Lithium Metal Battery by transport regulations, and is needed to consider special handling may apply. Please refer the latest regulations e.g. IATA, IMDG or DOT where transport this battery or/and any articles contain or assembled with this battery. This battery complies with UN Recommendation on the Transport of Dangerous Goods (UN38.3).
- 3) This battery does not contain any toxic materials, such as mercury, cadmium or lead.



10. Precautions for use

- 1) The battery shall not be stored at temperatures in excess of 45°C.
Storage at less than 35°C is recommended. Storage at less than -20°C can deform the plastic parts and may cause a leakage. To prevent self-discharge caused by corrosion or decrease of insulation, humidity during storage shall be less than 70%RH.
Do not expose batteries to direct sunlight or moisture in order to prevent deterioration of performance.
- 2) The battery has an explosion resistant construction. But the following cautions should be taken, because combustible materials such as Lithium metal and organic electrolyte are contained in the battery.
 - * Do not use except in applicable model or equipment.
 - * Do not connect more than two cells in series.
 - * Do not mix new (fresh) and old (end of life) batteries.
 - * Do not force-discharge.
 - * Do not mix different types (chemistries) of batteries.
 - * Do not short circuit.
 - * Do not dispose in fire.
 - * Do not charge.
 - * Do not disassemble.
 - * Do not heat up more than 100°C.
 - * Do not solder directly onto batteries.
 - * Do not soak in water.
 - * Do not deform.
 - * Do not inadequacy modify and remodel for installation.
 - * Insert the batteries in correct polarity position.

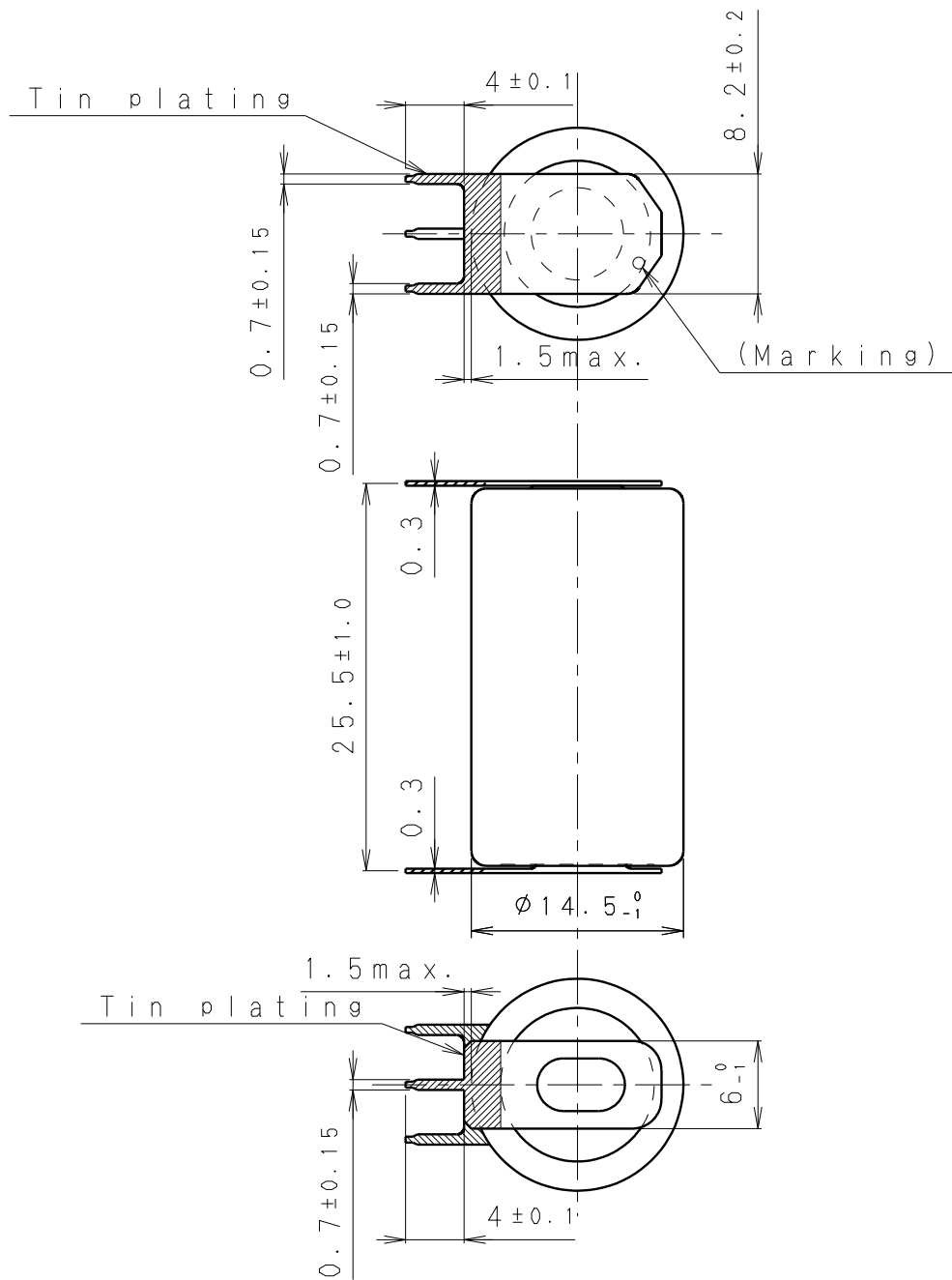
- 3) Keep away from heat source or flame.
- 4) Do not wash by ultrasonic wave washer.
- 5) Keep away from children and infants to prevent the possibility of swallowing by mistake.



* NOTE [注記]

1. TAB PULLING STRENGTH OVER 19.6N
[端子溶接強度：19.6N以上]
2. TAB MATERIAL: STAINLESS STEEL WITH TIN PLATING 
[端子材料：基材 ステンレス/表面 部分Snメッキ 
3. () : REFERENCE DIMENSION AND ANGLE
[() 寸法、角度は参考値]

PRODUCT NO.	BR-1/2AAE2PN	SCALE	
		2:1	
DRAWING NO.	PC-B12AA0442	REV.	
		0	

外装チューブ意匠図
Tube design

製品品番 Model Number	BR-1/2AA
図番 Drawing Number	13-650-08 R2
制定 Constitution	2008. 7. 16

Material : PET
t=90±20 μm

1:1



2:1

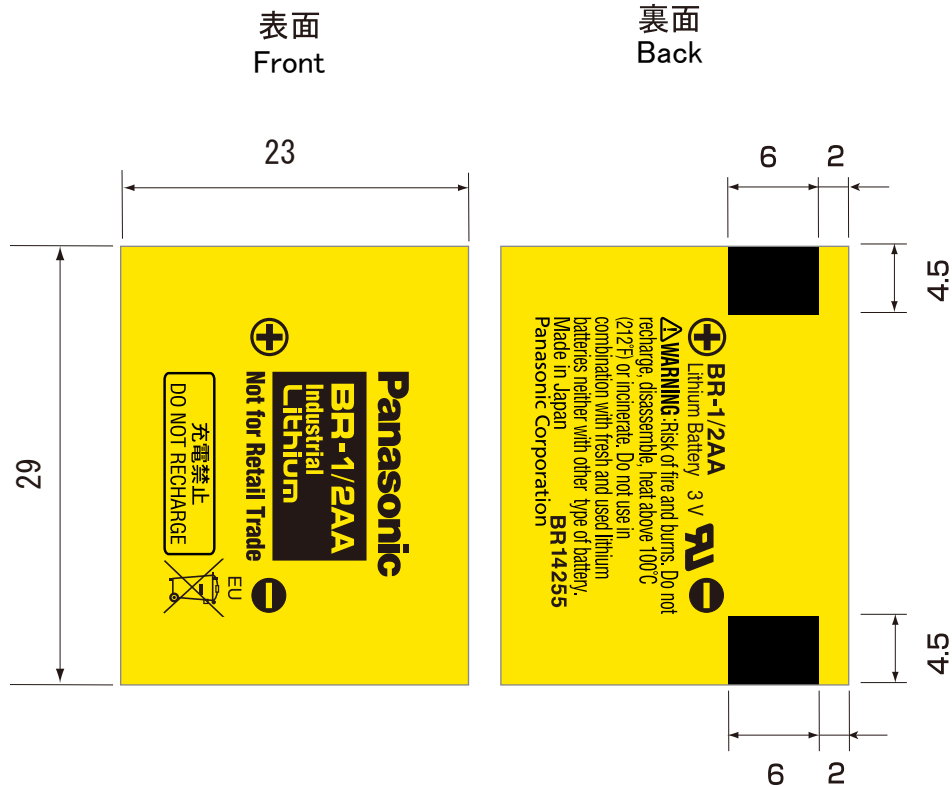

unit : mm

*

Packaging Specification

Drawing
Number

232-E12-001N_A

Lithium battery with tab

Tray for 50pcs.×Inner Sleeve for 200pcs.×Outer Carton for 200pcs.

1-Product

Refer to the product drawing

2-Tray for 50pcs.

*The battery shape is different by product number

The batteries polarity put same direction

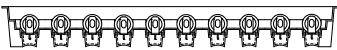
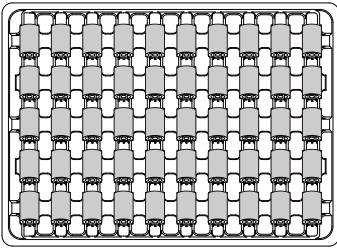

× 4

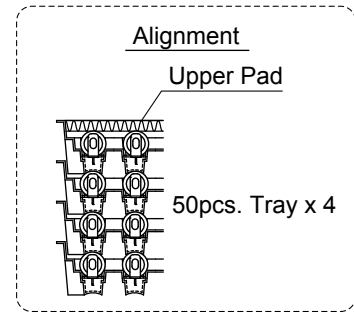

3-Inner Sleeve for 200pcs.

UL Warning PP tape

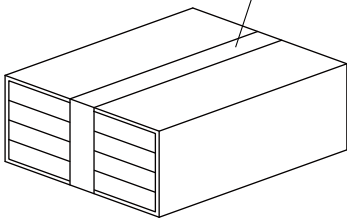

× 1



Top and bottom pad

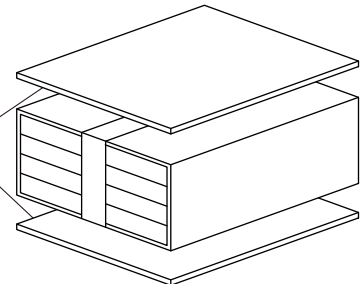

4-Outer Carton for 200pcs.

Dustbin Mark



Case Mark

Product No.
QTY.
Date code

PP Tape

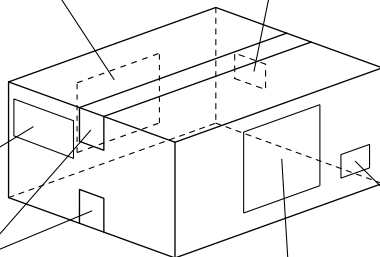

LBH Mark



UL Mark



Middle frame

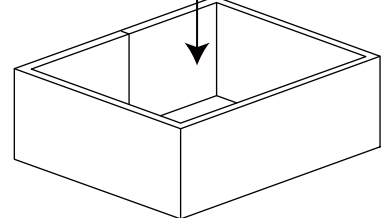

Packing List

Dimension : 280x220x150mm
M3 : 0.00924m³
Net : 1.60kg 8.0g/1pc.
Gross : 2.30kg

Battery Safety Practices

Avoiding hazards in lithium battery handling



Warning

Mishandling batteries can cause battery leakage, heat generation, rupture, ignition etc., that can lead to possible fire or injury.

Both of coin type and cylinder type of lithium batteries contain flammable materials such as lithium, organic solvent and other chemical ingredients. Improper handling of lithium batteries may result in heat generation, fire or explosion, with a risk of personal injury or damage. To prevent these accidents in battery handling, be sure to observe the following precautions.

1. Do not Short circuit

Direct connection of plus(+) and minus(-) poles may result in leakage, heat generation, explosion and/or fire.
Do not store and/or carry batteries with metallic product such as necklace. (Refer fig.1)

Fig. 1 Short circuit

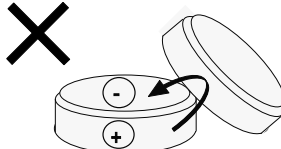

Fig. 2 stacked & jumble batteries



2. Do not stack and/or jumble batteries

Stacked and/or jumbled batteries may cause short circuit and/or forced discharge by the contact of other batteries. This may result in leakage, heat generation, explosion and/or fire.

Especially, a connection with the 006P(9V) type batteries may have a high risk of leakage, heat generation, explosion and/or fire. (Refer fig.2 & 3)

3. Do not make forced discharge batteries

Forced discharge by external power source, the battery voltage goes to negative and this cause gas generation in inside of the battery. This may result in leakage, heat generation, explosion and/or fire. (Refer fig.3)

* In your disposal and/or storage of the batteries, please isolate plus and minus poles by adhesive tape. A connection with other metals and/or batteries may result in leakage, heat generation, explosion and/or fire.

* When using the stored battery, please remove the tape perfectly to avoid high contact resistance problem. (Refer fig.4)

4. Do not dispose of batteries in fire

Disposal of batteries in fire is extremely dangerous with a risk of explosion and violent flaring.

5. Do not heat batteries

Heating batteries above 100 (212°F) may damage the resin in crimping, separator and other parts, causing electrolyte leak, internal short circuit, fire and explosion.

6. Do not solder directly onto batteries

Direct soldering onto batteries may damage the resin in crimping, separator and other parts, causing electrolyte leak, internal short circuit, fire and explosion.

7. Do not charge batteries

Charging of primary batteries may result internal gas generation, causing electrolyte leak, battery swelling, fire and explosion.

8. Do not disassemble batteries

Disassembly batteries may cause gas generation that may irritate your throat. Lithium may also react with moisture to generate heat and fire.

9. Do not deform batteries

Applying extreme pressure to batteries may cause deformation of the crimping and internal short circuit, causing electrolyte leak, battery swelling, fire and explosion.

10. Do not mix different type batteries

For some applications, mixing of different type batteries, or new and old batteries, can cause over discharge due to differences in voltage and discharge capacities. This may lead to the risk of swelling and/or explosion.

11. Do not insert batteries with opposite polarity

For some applications, battery insertion with opposite polarity (reverse insertion of plus and minus) may result in leakage, heat generation, explosion and/or fire.

Please ensure the above precautions are strictly observed by related divisions including production departments, sales departments and external subcontractors. For additional details and information, please contact our sales representatives.

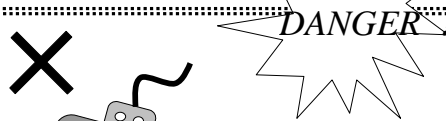
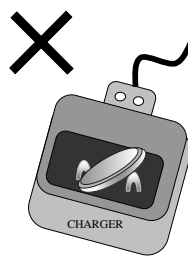

Fig. 3
Examples of forced discharge



Connection with battery charger

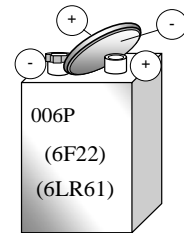

Fig. 4
Examples of isolation in disposal and/or storage

